



Designed by
Studio Kairos

Borges BORGES S3 J1616NK

Borges is a high-quality executive desk that transforms your office into a sophisticated and efficient space. The injection-molded aluminum legs and sleek black chrome surface combine modern aesthetics with durability. Borges elevates your workspace to new heights of style and performance.

Warranty / Cleaning & Maintenance

The warranty period is five years from the date of delivery. Check the QR code below, to see cleaning & maintenance information.

COLORS & MATERIALS

Metal Finishes



SATIN EPOXY
POWDER COATING



3101 WHITE EPOXY
POWDER COATING



3101 WHITE EPOXY
POWDER COATING

Laminate Finishes



Production Time / Assembly Notes



6-8 weeks + Shipping
The product is delivered disassembled.

Product Description

- Dual-user desk series; tabletop made of 18 mm chipboard with laminate surface and 2 mm thick edge banding.
- Featuring two powder-coated sheet metal cable grommet and a cable management tray attached under the desk.
- The storage unit's body and top panel are made of 18 mm laminated chipboard with 2 mm thick edge banding.
- The storage unit includes two drawers and a desktop computer tower compartment. At the bottom of the desktop computer tower compartment, includes an internal circular cable access port at the base.
- The top drawer is equipped with a locking system and the product comes with two sets of keys.
- The legs are powder-coated aluminum.
- The models in this series are compatible with Koleksiyon APF panel series.

*For accurate sizing and model selection, please refer to the Koleksiyon screen spec sheet or usage chart.

Dimension

	Volume	0.9 m3 31.78 cbft3
	Package	5
	Weight	0 kg 0 lbs

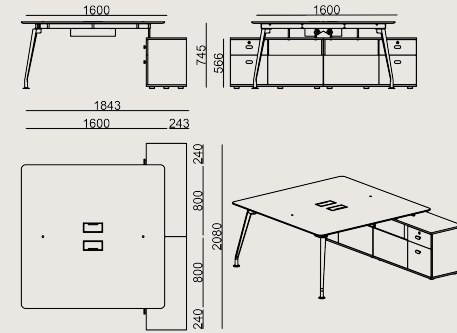

BORGES S4 J1616NK LAMINATE_EPOXY
Overall Width: 1600 mm / 62.99"
Overall Depth: 1600 mm / 62.99"
Overall Height: 745 mm / 29.33"

Scan for all
colors & materials & catalogs

