



Designed by
Faruk Malhan

Porte PORTE S1 G1612NKT

The Porte Series offers an ideal solution for operational offices with desks designed to meet various needs, from single-user setups to six-person configurations. With its design that seamlessly fits into modern work environments, it combines efficiency, flexibility, and aesthetics.

Warranty / Cleaning & Maintenance

The warranty period is five years from the date of delivery. Check the QR code below, to see cleaning & maintenance information.

COLORS & MATERIALS

Metal Finishes



SATIN EPOXY
POWDER COATING

3101 WHITE EPOXY
POWDER COATING



3101 WHITE EPOXY
POWDER COATING

Laminate Finishes



Production Time / Assembly Notes



6-8 weeks + Shipping
The product is delivered disassembled.

Product Description

- Dual-user desk series; tabletop made of 18 mm chipboard with laminate surface and 2 mm thick edge banding.
- Featuring two powder-coated sheet metal cable grommet and a cable management tray attached under the desk.
- The Vertebra cable management system should be ordered separately.
- The legs are powder-coated metal.
- The models in this series are compatible with Koleksiyon APF panel series.

*For accurate sizing and model selection, please refer to the Koleksiyon screen spec sheet or usage chart.

Dimension

 Volume	0.39 m3 13.77 cbft3
 Package	4
 Weight	0 kg 0 lbs

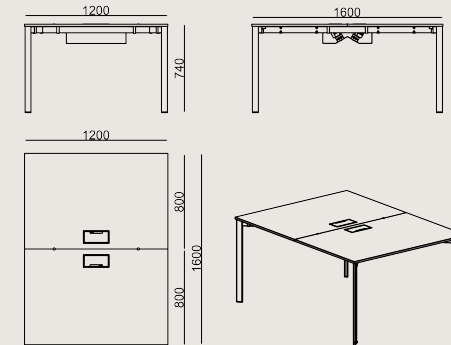

PORTE S1 G1612NKT LAMINATE EPOXY
Overall Width: 1200 mm / 47.24"
Overall Depth: 1600 mm / 62.99"
Overall Height: 740 mm / 29.13"

Scan for all
colors & materials & catalogs

