



Designed by
Koray Malhan

Threshold

THRESHOLD S0 G2_1612N

Threshold is a versatile series of desking, self-standing desks, and storage units. It offers an open and flexible system that can be easily combined and configured to suit both compact and spacious environments.

Warranty / Cleaning & Maintenance

The warranty period is five years from the date of delivery. Check the QR code below, to see cleaning & maintenance information.

COLORS & MATERIALS

Metal Finishes



SATIN EPOXY
POWDER COATING



RAL 7021
ANTHRACITE EPOXY
POWDER COATING



3101 WHITE EPOXY
POWDER COATING

Laminate Finishes



3101 WHITE



3153 OFIS GREY



VT925 WHITE OAK



VT053 SMOKED OAK



VT459 GREY

Lacquered Finishes



RAL 9010 WHITE
LACQUER



RAL 7021
ANTHRACITE
LACQUER

Production Time / Assembly Notes

6-8 weeks + Shipping



The product is delivered disassembled.

Product Description

- Dual-user desk series; featuring 18 mm lacquered MDF side panels on both ends and a tabletop made of 18 mm laminated chipboard with 2 mm edge banding.
- Featuring two powder-coated sheet metal cable grommet and a cable management tray attached under the desk.
- The Vertebra cable management system should be ordered separately.
- The legs are aluminum profiles with a powder-coated finish.
- The models in this series are compatible with Koleksiyon APF panel series.

*For accurate sizing and model selection, please refer to the Koleksiyon screen spec sheet or usage chart.

Dimension

 Volume	0.59 m3 20.84 cbft3
 Package	4
 Weight	0 kg 0 lbs

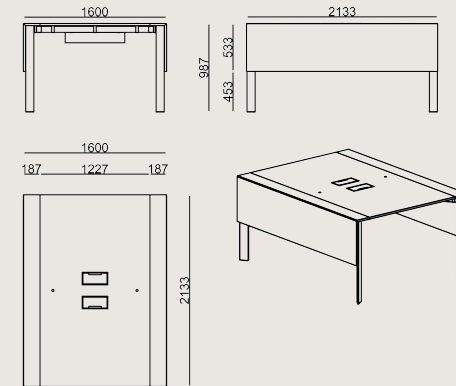

THRESHOLD S0 G2_0812N LAMINATE EPX LACQ
Overall Width: 1200 mm / 47.24"
Overall Depth: 1600 mm / 62.99"
Overall Height: 740 mm / 29.13"

Scan for all
colors & materials & catalogs

